



Multi-Modal Transit Center
by Aaron Uhe



Multi-Modal Transit Center				
First Floor-Public	# of Type	Sq. Ft. per Type	Total Sq. Ft.	Use and Occupancy Classification
Bike Station	1	1,200.00	1,200.00	
Bus and Pick-Up Waiting Area	1	1,200.00	1,200.00	Assembly Group A-3
Convenience Store/SJSU Team Store	1	2,000.00	2,000.00	Mercantile Group M
Information Desk	1	600.00	600.00	
Lobby	1	1,000.00	1,000.00	Assembly Group A-3
Restaurant	1	1,200.00	1,200.00	Assembly Group A-3
Restrooms	4	350.00	1,400.00	
Retail Type A	3	750.00	2,250.00	Mercantile Group M
Retail Type B	1	1,200.00	1,200.00	Mercantile Group M
Second Floor-Mix	# of Type	Sq. Ft.	Total Sq. Ft.	Use and Occupancy Classification
ATN Gate	6	65.00	390.00	
ATN Waiting Area	1	1,200.00	1,200.00	Assembly Group A-3
Restrooms	2	350.00	700.00	
Third Floor-Private	# of Type	Sq. Ft.	Total Sq. Ft.	Use and Occupancy Classification
Control Room	1	1,200.00	1,200.00	Business Group B
San Jose Traffic Management Center	1	6,000.00	6,000.00	Business Group B
ATN Transportation Offices	1	750.00	750.00	Business Group B
Leasable Office Space A	3	750.00	2,250.00	Business Group B
Leasable Office Space B	1	1,200.00	1,200.00	Business Group B
Restrooms	2	350.00	700.00	
Site	# of Type	Sq. Ft.	Total Sq. Ft.	Use and Occupancy Classification
ATN Maintenance/Storage Area	1	15,000.00	15,000.00	Utility and Miscellaneous Group U
SJSU Athletic Department/Park and Ride Parking Garage				
Parking Garage	1	400,000.00	400,000.00	Low-Hazard Storage, Group S-2
Athletic Department Offices	1	24,000.00	24,000.00	
Banquet Hall	1	10,000.00	10,000.00	
Retail Spaces	1	20,000.00	20,000.00	

Additional Programming Will be Added in the Future





Site Location

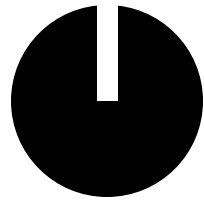

Legend

 Site





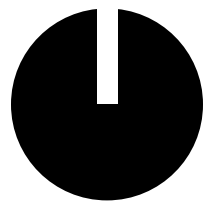

Site With Zoning



Legend

-  Combined Industrial/
Commercial
-  Heavy Industrial
-  Public/Quasi-Public





Spring

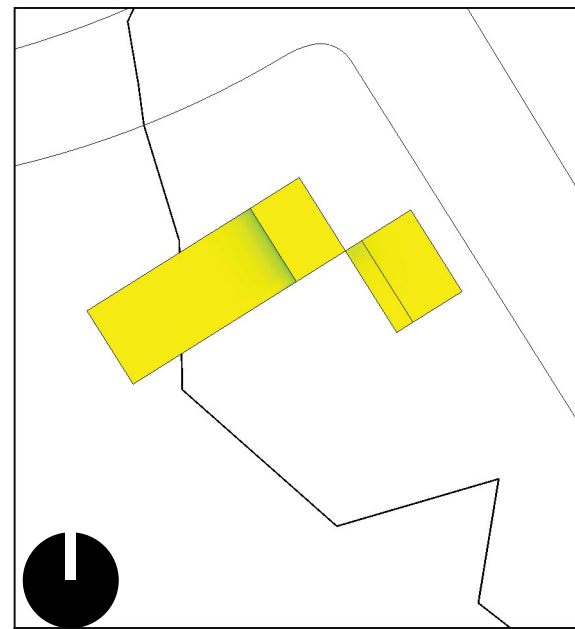
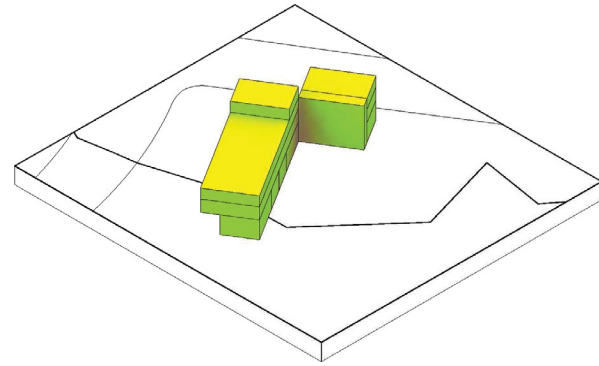

Custom Solar (kWh/m²)

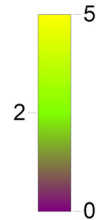

Project location: 37.3182487487793,-121.867973327637
Sun study start date time: 3/20/2017 6:12:00 AM
Sun study end date time: 3/20/2017 6:17:00 PM

Summer

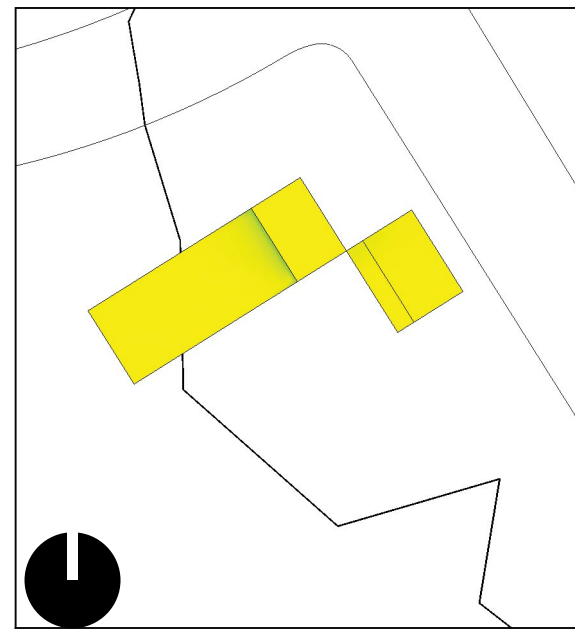
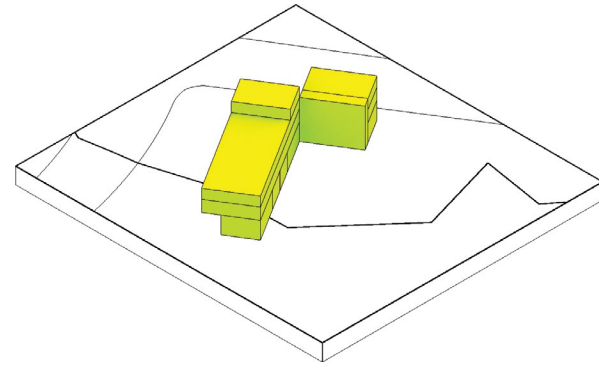

Custom Solar (kWh/m²)

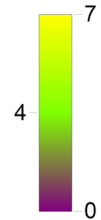

Project location: 37.3182487487793,-121.867973327637
Sun study start date time: 6/21/2017 4:48:00 AM
Sun study end date time: 6/21/2017 7:29:00 PM

Fall

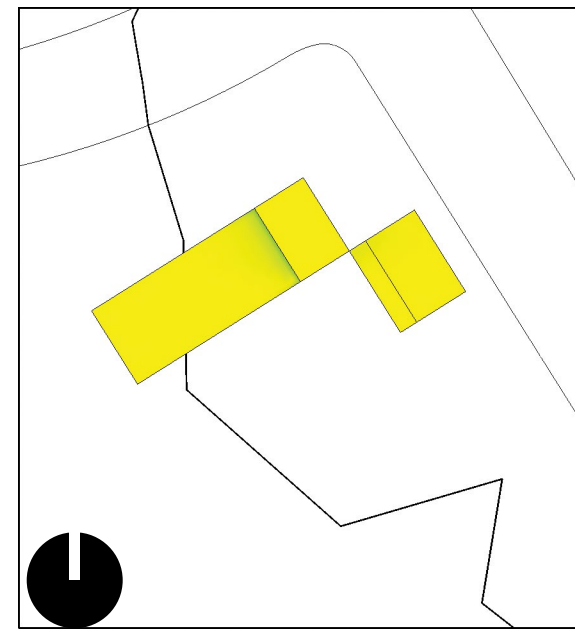
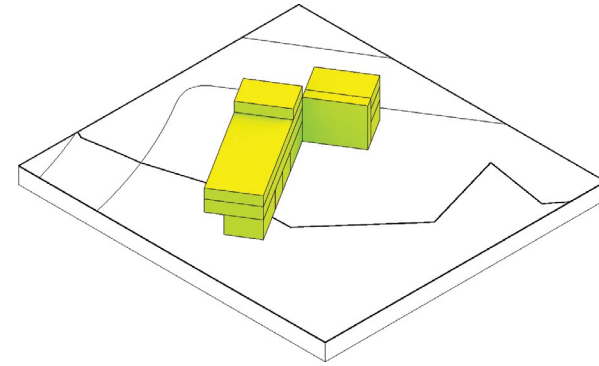

Custom Solar (kWh/m²)

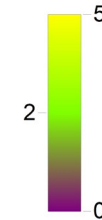

Project location: 37.3182487487793,-121.867973327637
Sun study start date time: 9/21/2017 5:55:00 AM
Sun study end date time: 9/21/2017 6:06:00 PM

Winter

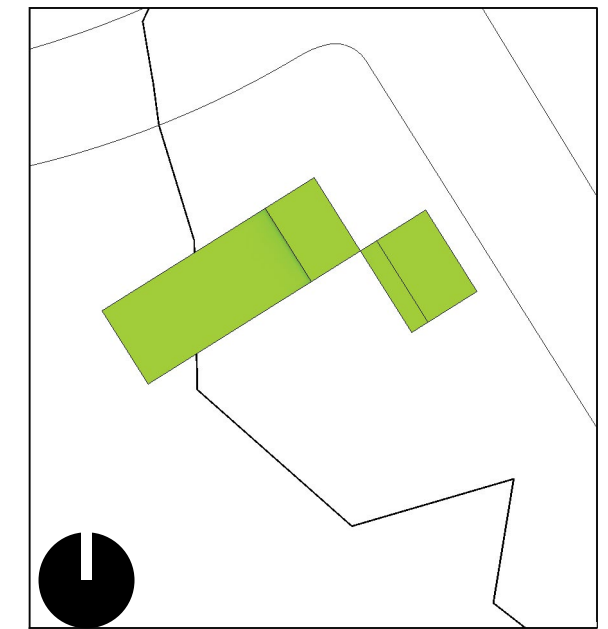
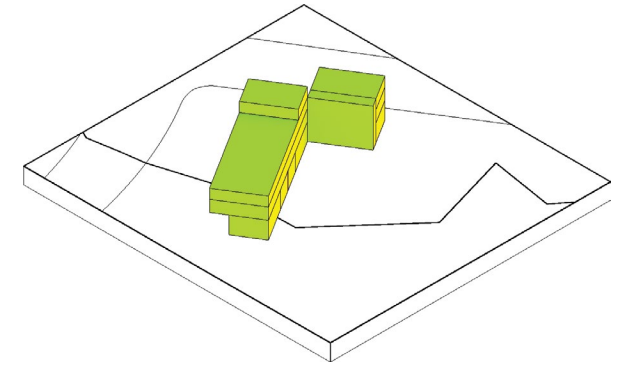

Custom Solar (kWh/m²)

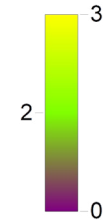

Project location: 37.3182487487793,-121.867973327637
Sun study start date time: 12/21/2017 7:19:00 AM
Sun study end date time: 12/21/2017 4:51:00 PM



Spring

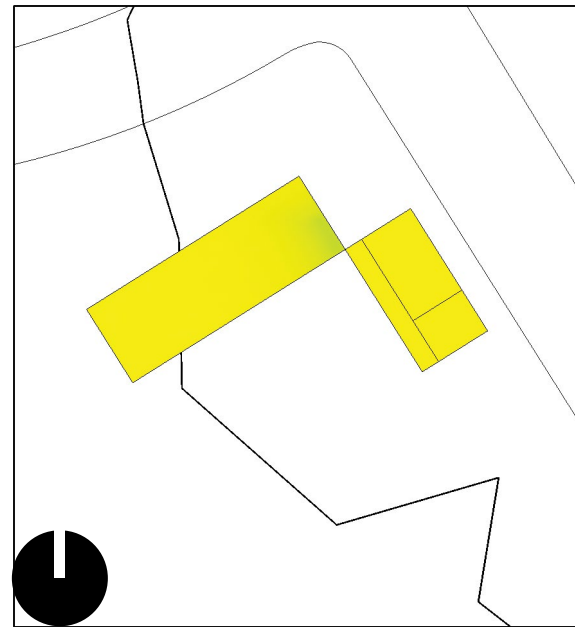
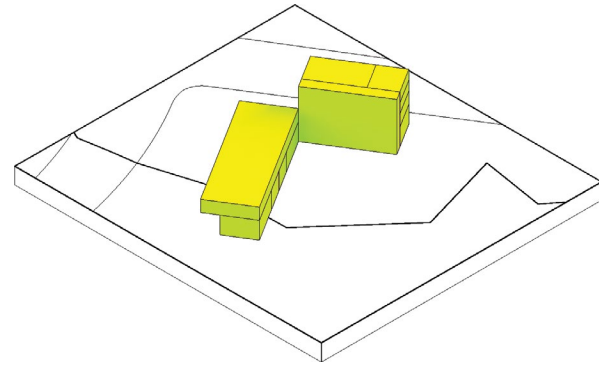

Custom Solar (kWh/m²)

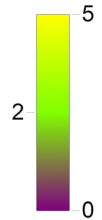

Project location: 37.3182487487793,-121.867973327637
Sun study start date time: 3/20/2017 6:12:00 AM
Sun study end date time: 3/20/2017 6:17:00 PM

Summer

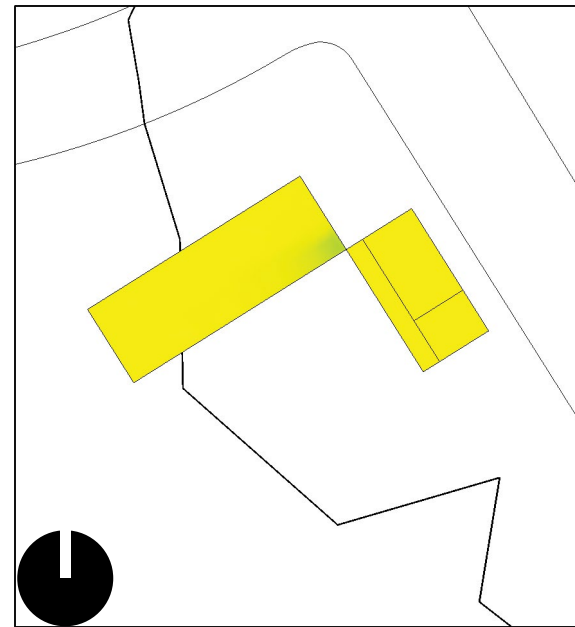
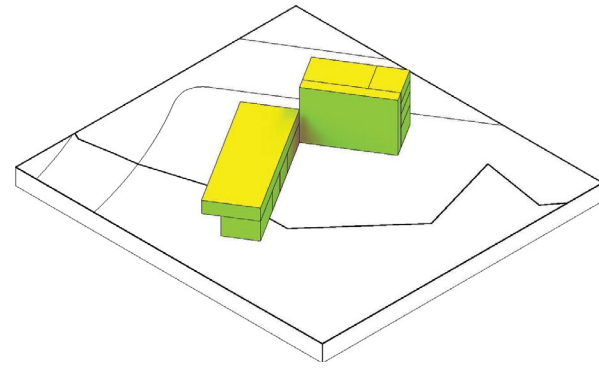

Custom Solar (kWh/m²)

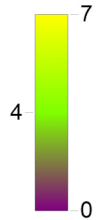

Project location: 37.3182487487793,-121.867973327637
Sun study start date time: 6/21/2017 4:48:00 AM
Sun study end date time: 6/21/2017 7:29:00 PM

Fall

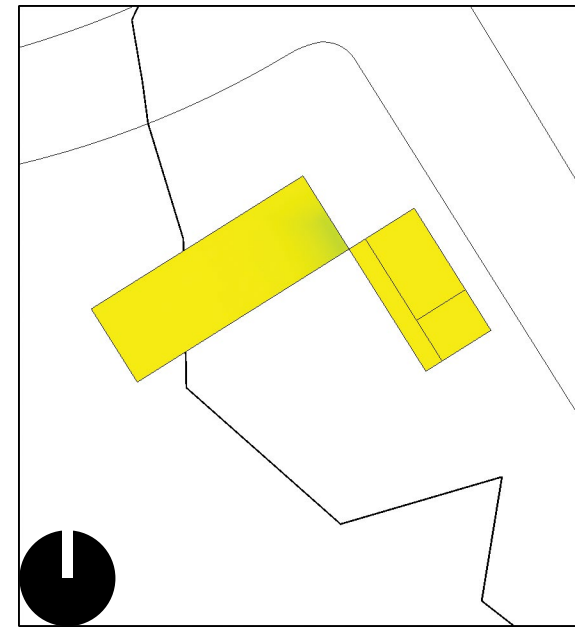
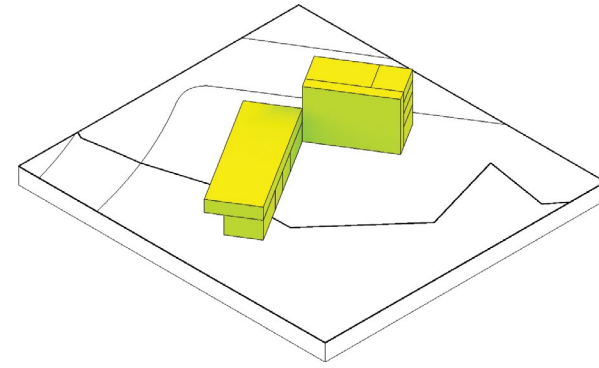

Custom Solar (kWh/m²)

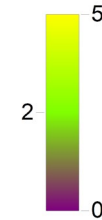

Project location: 37.3182487487793,-121.867973327637
Sun study start date time: 9/21/2017 5:55:00 AM
Sun study end date time: 9/21/2017 6:06:00 PM

Winter

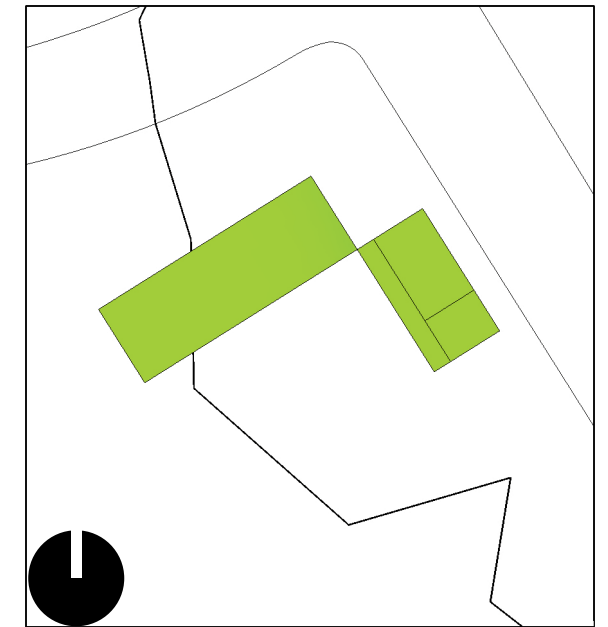
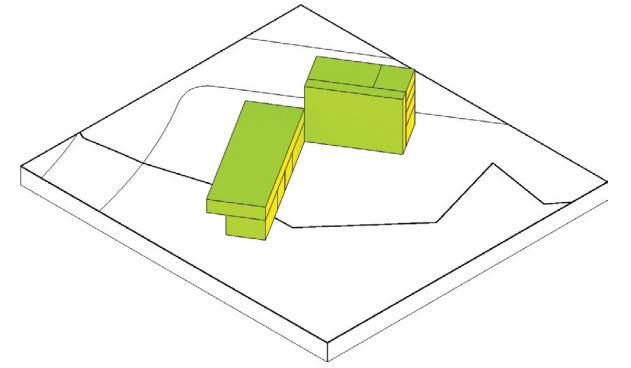

Custom Solar (kWh/m²)

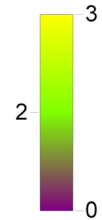

Project location: 37.3182487487793,-121.867973327637
Sun study start date time: 12/21/2017 7:19:00 AM
Sun study end date time: 12/21/2017 4:51:00 PM



Spring

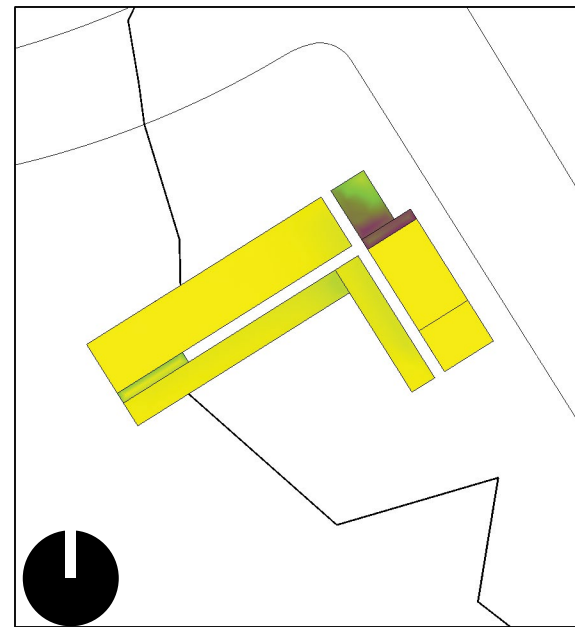
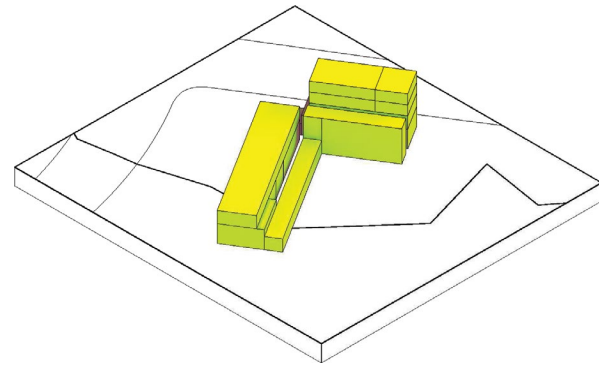

Custom Solar (kWh/m²)

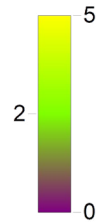

Project location: 37.3182487487793, -121.867973327637
 Sun study start date time: 3/20/2017 6:12:00 AM
 Sun study end date time: 3/20/2017 6:17:00 PM

Summer

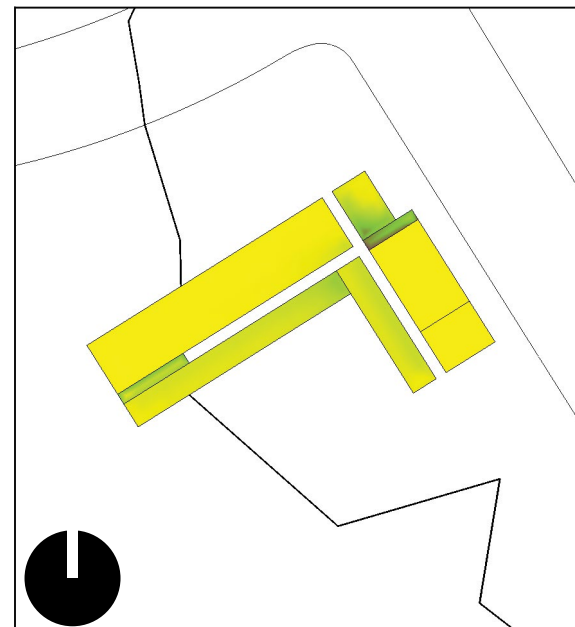
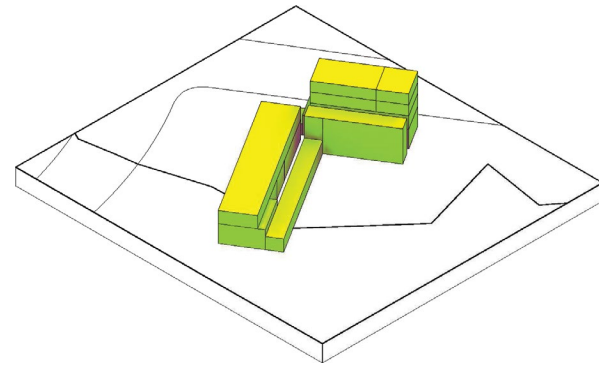

Custom Solar (kWh/m²)

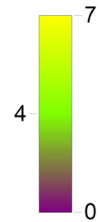

Project location: 37.3182487487793, -121.867973327637
 Sun study start date time: 6/21/2017 4:48:00 AM
 Sun study end date time: 6/21/2017 7:29:00 PM

Fall

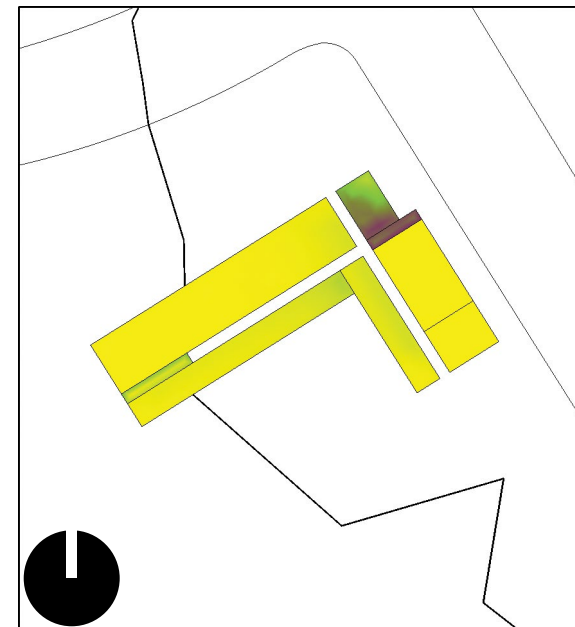
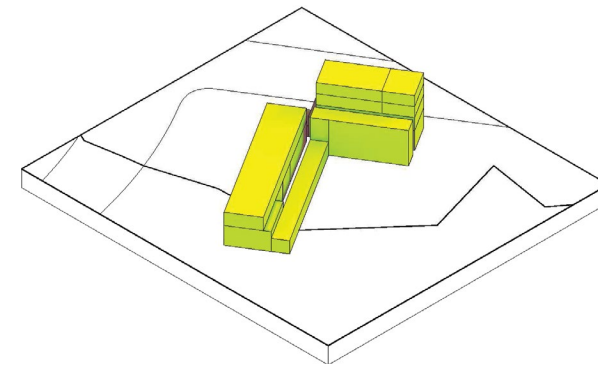

Custom Solar (kWh/m²)

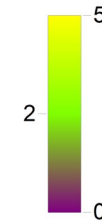

Project location: 37.3182487487793, -121.867973327637
 Sun study start date time: 9/21/2017 5:55:00 AM
 Sun study end date time: 9/21/2017 6:06:00 PM

Winter

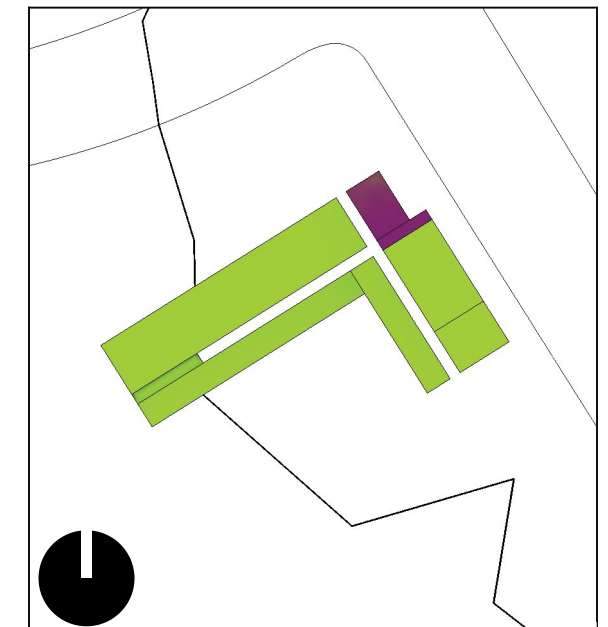
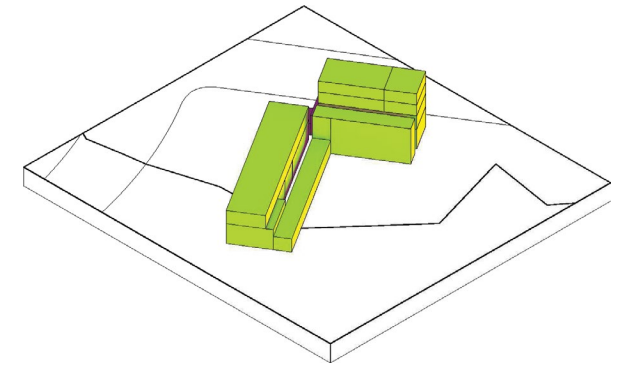

Custom Solar (kWh/m²)

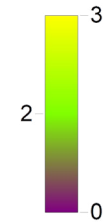

Project location: 37.3182487487793, -121.867973327637
 Sun study start date time: 12/21/2017 7:19:00 AM
 Sun study end date time: 12/21/2017 4:51:00 PM



Spring

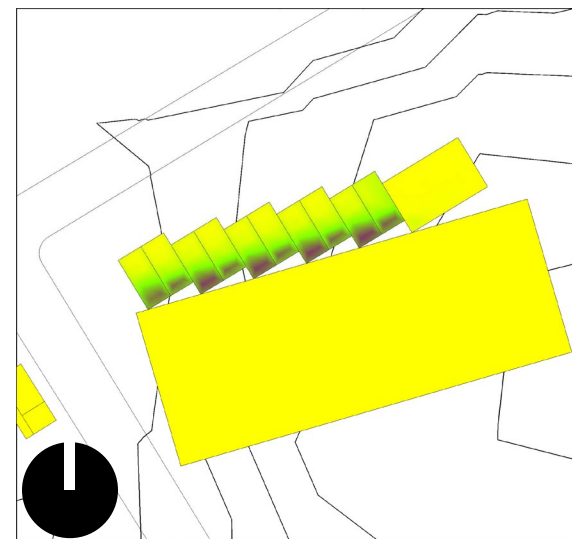
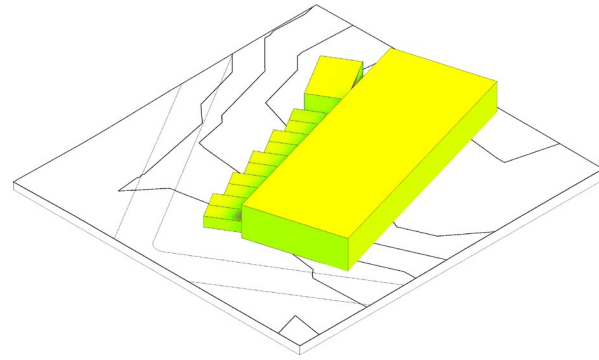

Custom Solar (kWh/m²)

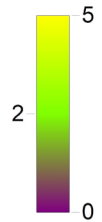

Project location: 37.3182487487793,-121.867973327637
Sun study start date time: 3/20/2017 6:12:00 AM
Sun study end date time: 3/20/2017 6:17:00 PM

Summer

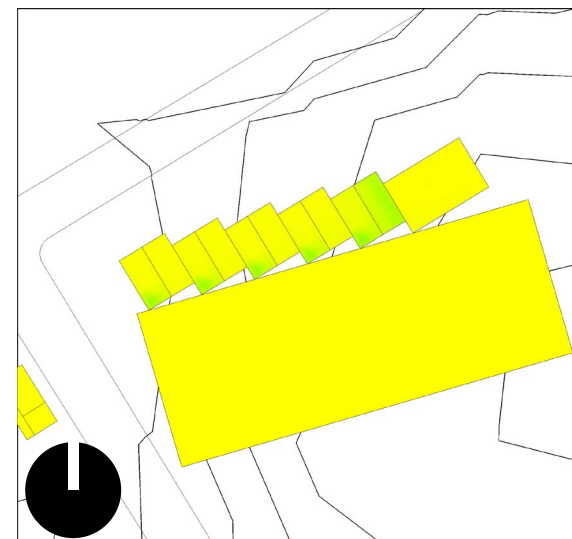
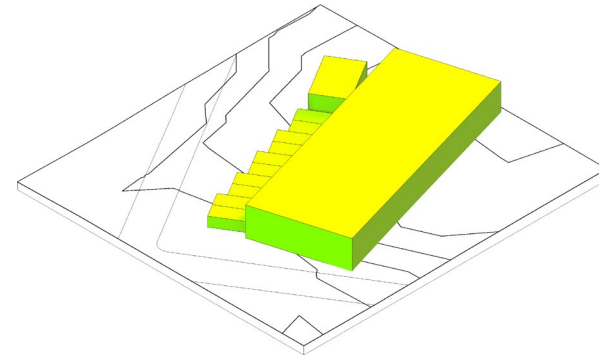

Custom Solar (kWh/m²)

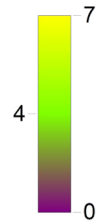

Project location: 37.3182487487793,-121.867973327637
Sun study start date time: 6/21/2017 4:48:00 AM
Sun study end date time: 6/21/2017 7:29:00 PM

Fall

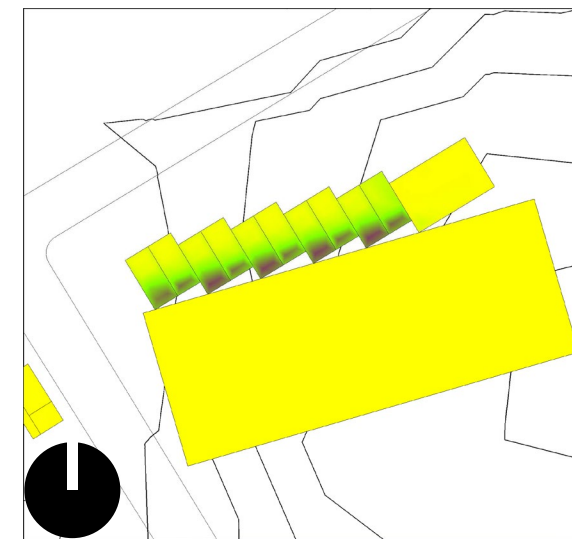
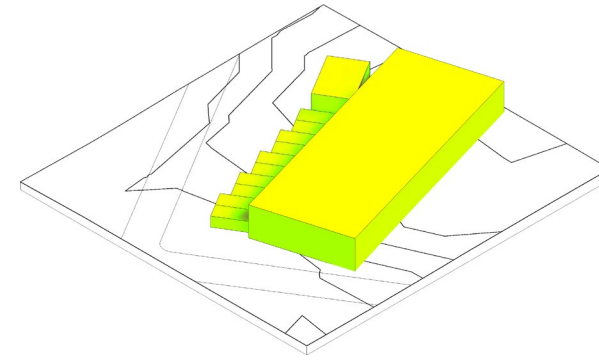

Custom Solar (kWh/m²)

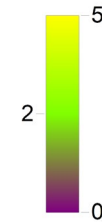

Project location: 37.3182487487793,-121.867973327637
Sun study start date time: 9/21/2017 5:55:00 AM
Sun study end date time: 9/21/2017 6:06:00 PM

Winter

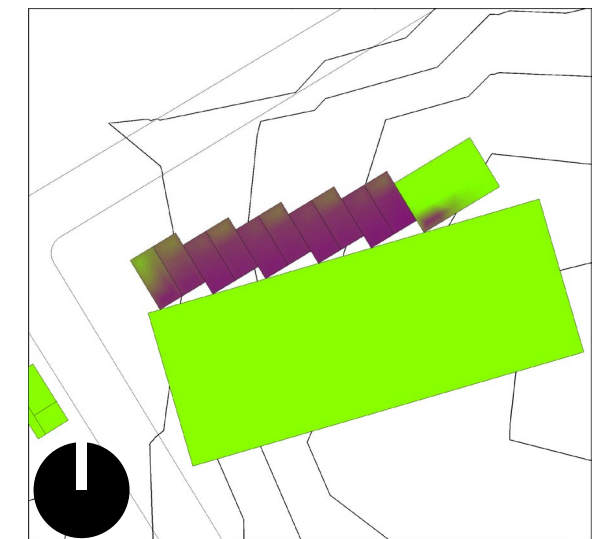
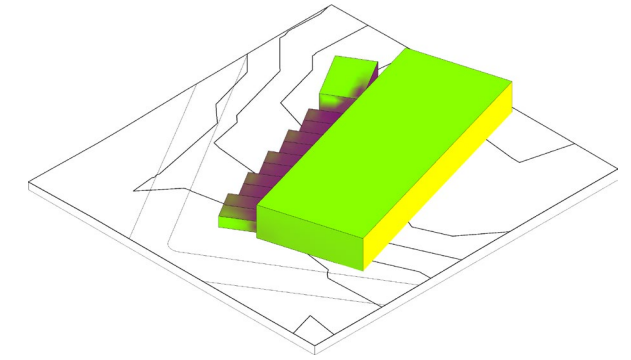

Custom Solar (kWh/m²)

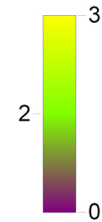

Project location: 37.3182487487793,-121.867973327637
Sun study start date time: 12/21/2017 7:19:00 AM
Sun study end date time: 12/21/2017 4:51:00 PM



Spring

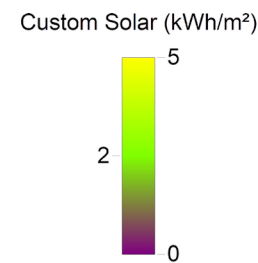
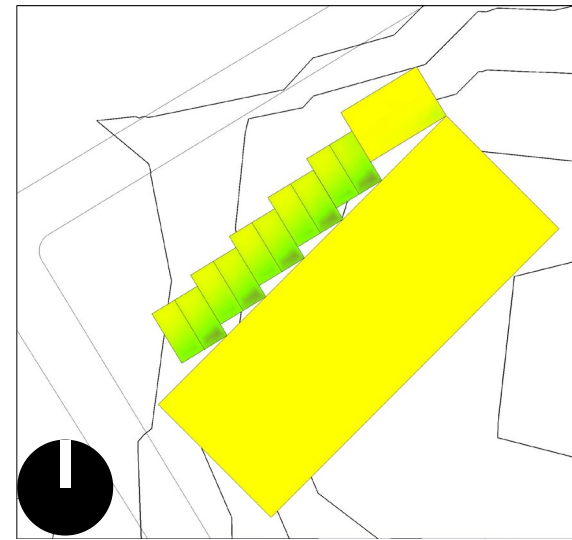
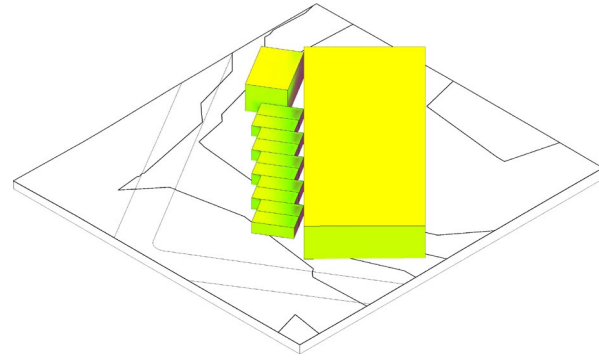

Project location: 37.3182487487793,-121.867973327637
Sun study start date time: 3/20/2017 6:12:00 AM
Sun study end date time: 3/20/2017 6:17:00 PM

Summer

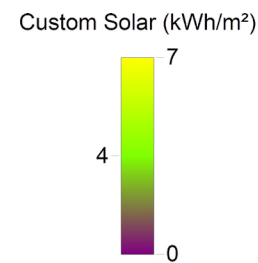
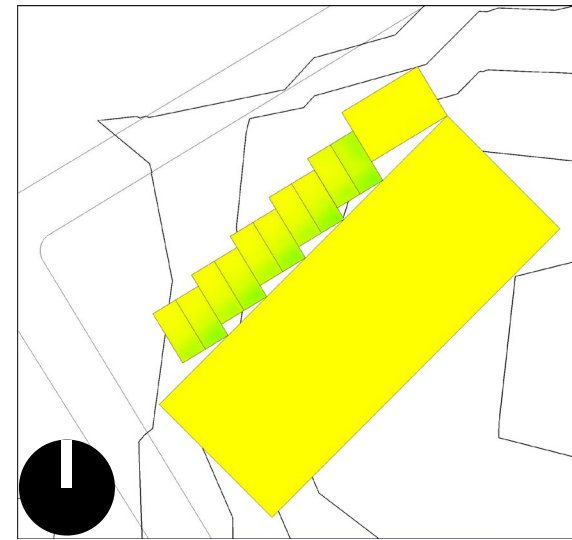
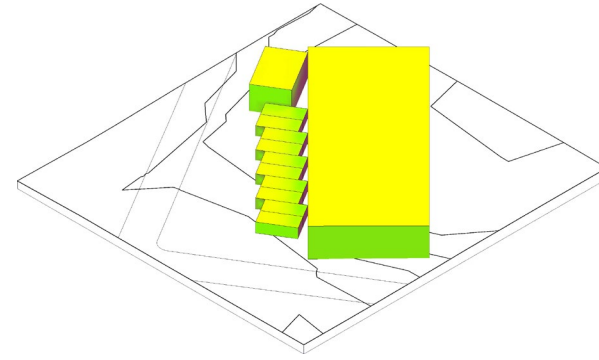

Project location: 37.3182487487793,-121.867973327637
Sun study start date time: 6/21/2017 4:48:00 AM
Sun study end date time: 6/21/2017 7:29:00 PM

Fall

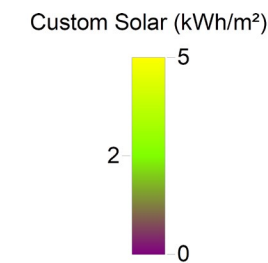
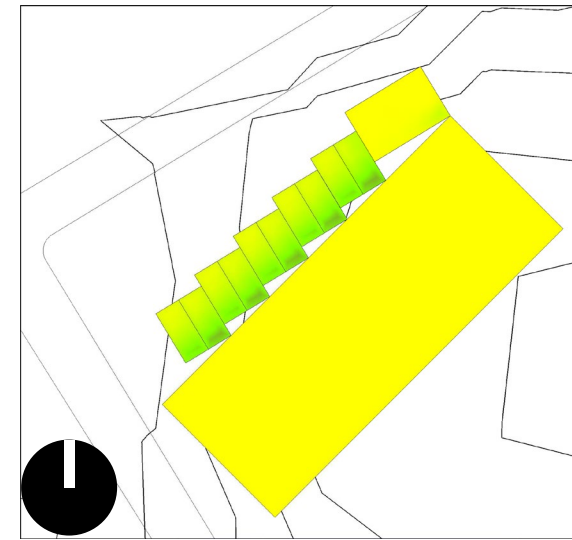
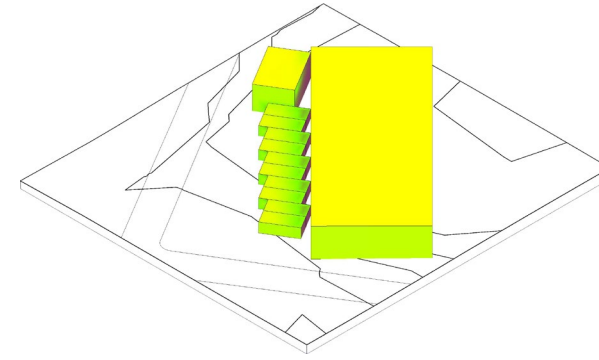

Project location: 37.3182487487793,-121.867973327637
Sun study start date time: 9/21/2017 5:55:00 AM
Sun study end date time: 9/21/2017 6:06:00 PM

Winter

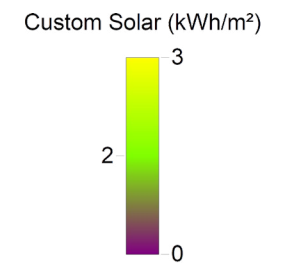
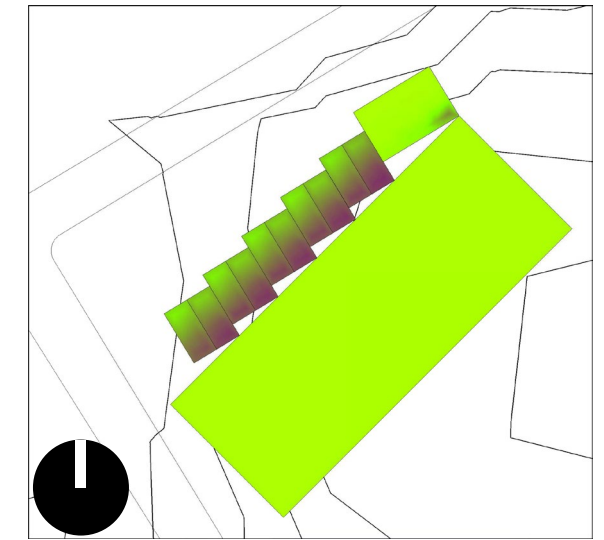
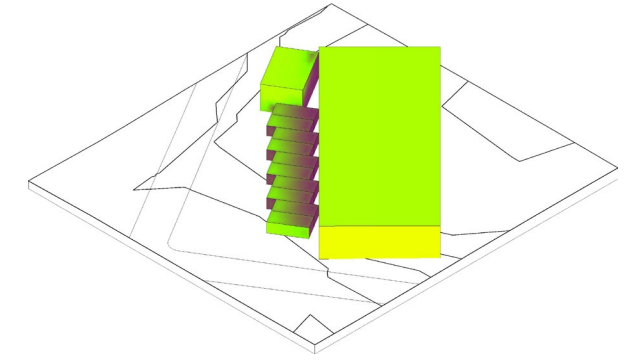

Project location: 37.3182487487793,-121.867973327637
Sun study start date time: 12/21/2017 7:19:00 AM
Sun study end date time: 12/21/2017 4:51:00 PM



Spring

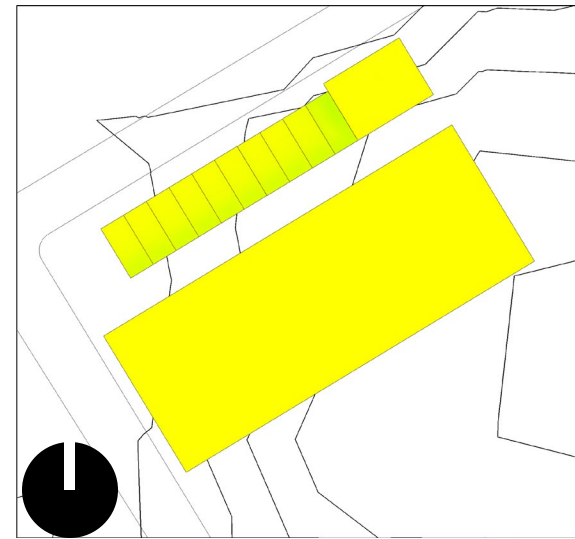
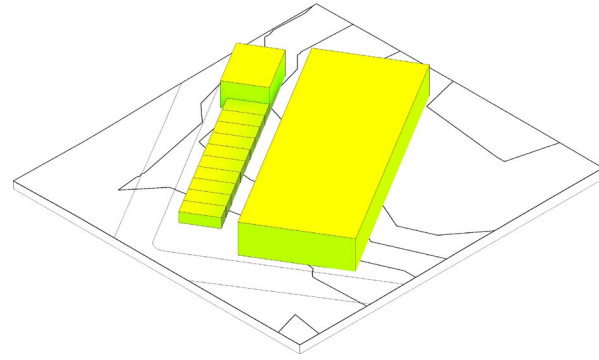

Custom Solar (kWh/m²)

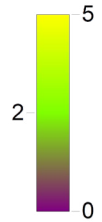

Project location: 37.3182487487793,-121.867973327637
 Sun study start date time: 3/20/2017 6:12:00 AM
 Sun study end date time: 3/20/2017 6:17:00 PM

Summer

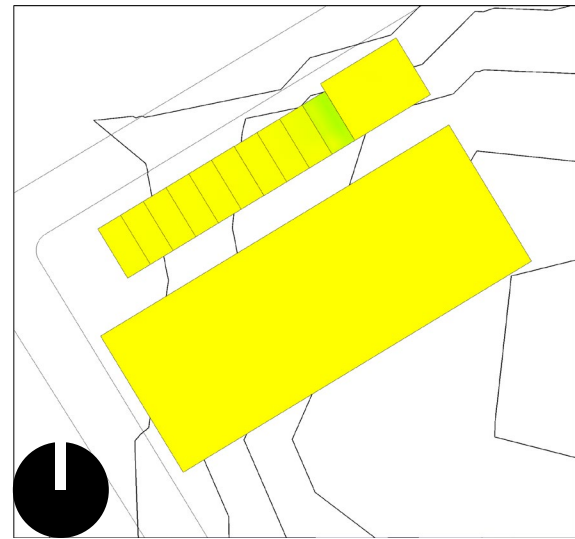
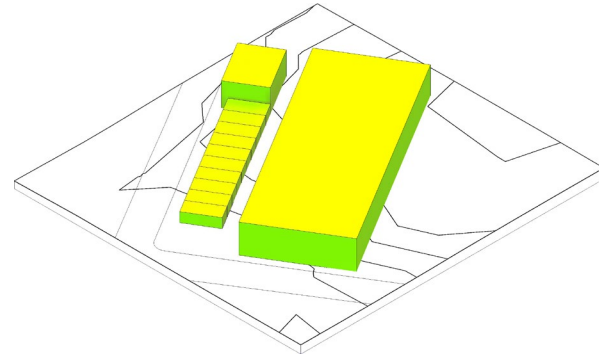

Custom Solar (kWh/m²)

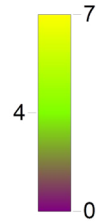

Project location: 37.3182487487793,-121.867973327637
 Sun study start date time: 6/21/2017 4:48:00 AM
 Sun study end date time: 6/21/2017 7:29:00 PM

Fall

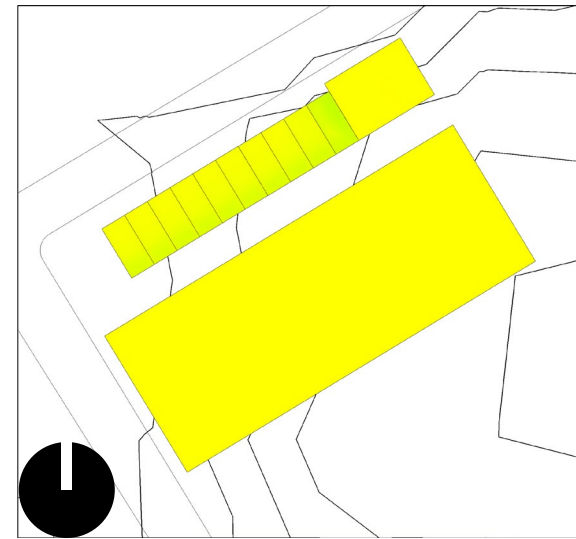
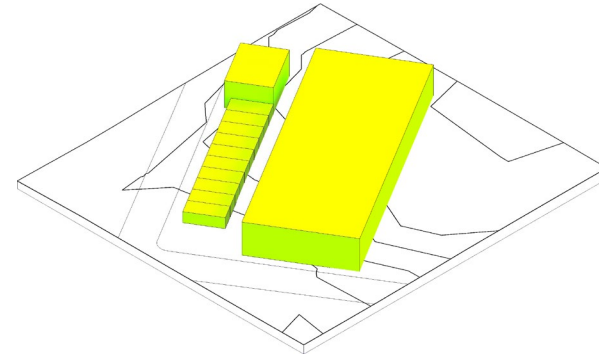

Custom Solar (kWh/m²)

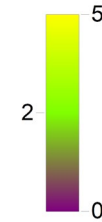

Project location: 37.3182487487793,-121.867973327637
 Sun study start date time: 9/21/2017 5:55:00 AM
 Sun study end date time: 9/21/2017 6:06:00 PM

Winter

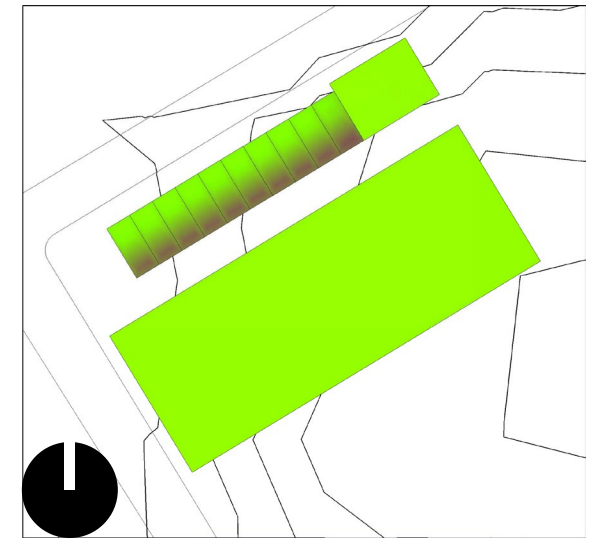
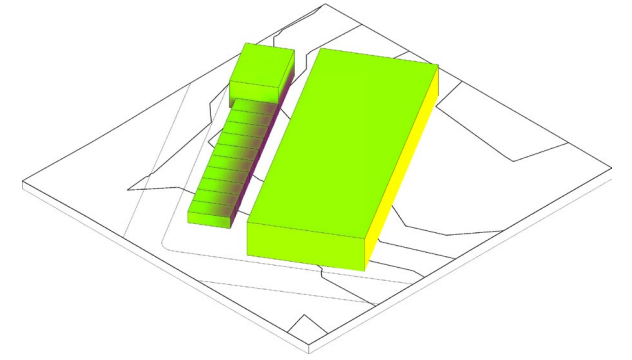

Custom Solar (kWh/m²)

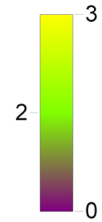





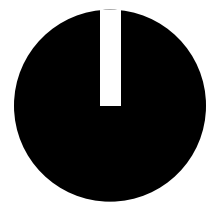

Project location: 37.3182487487793,-121.867973327637
 Sun study start date time: 12/21/2017 7:19:00 AM
 Sun study end date time: 12/21/2017 4:51:00 PM



Major Program Layout



Legend

-  Athletic Department
-  Entrance/Info
-  Old Athletic Department
-  Parking Garage
-  Private/Offices
-  Public/Transit
-  Restaurant/Retail







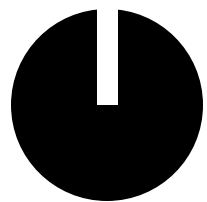



Transit First Floor



Legend

-  Bike Station
-  Retail
-  Restaurant
-  Stair
-  Toilet
-  Transportation Offices

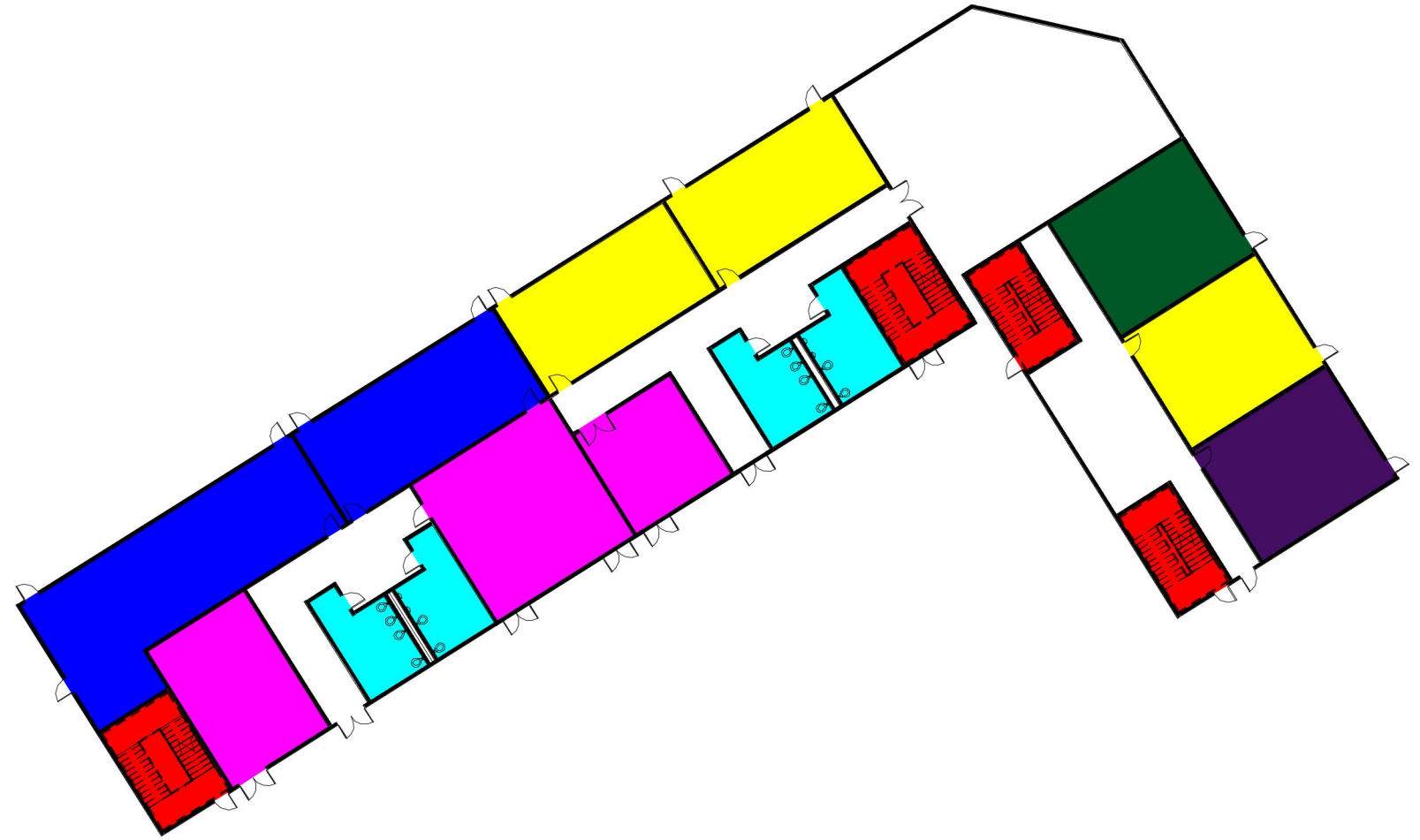



Transit Second Floor

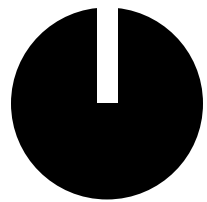

Legend

 ATN Waiting Area

 Stairway

 Toilet

 Transportation Offices

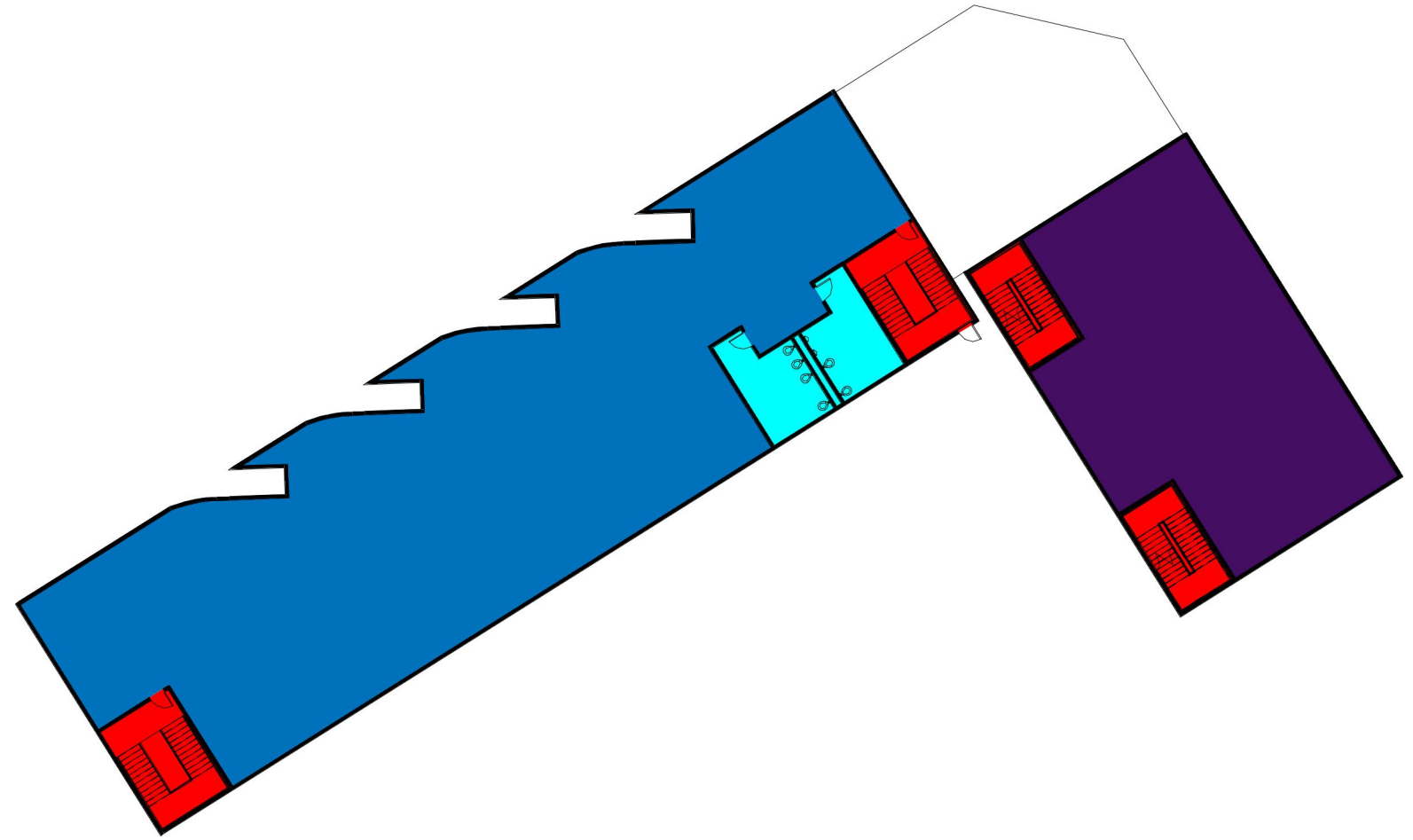



E Alma Avenue Section

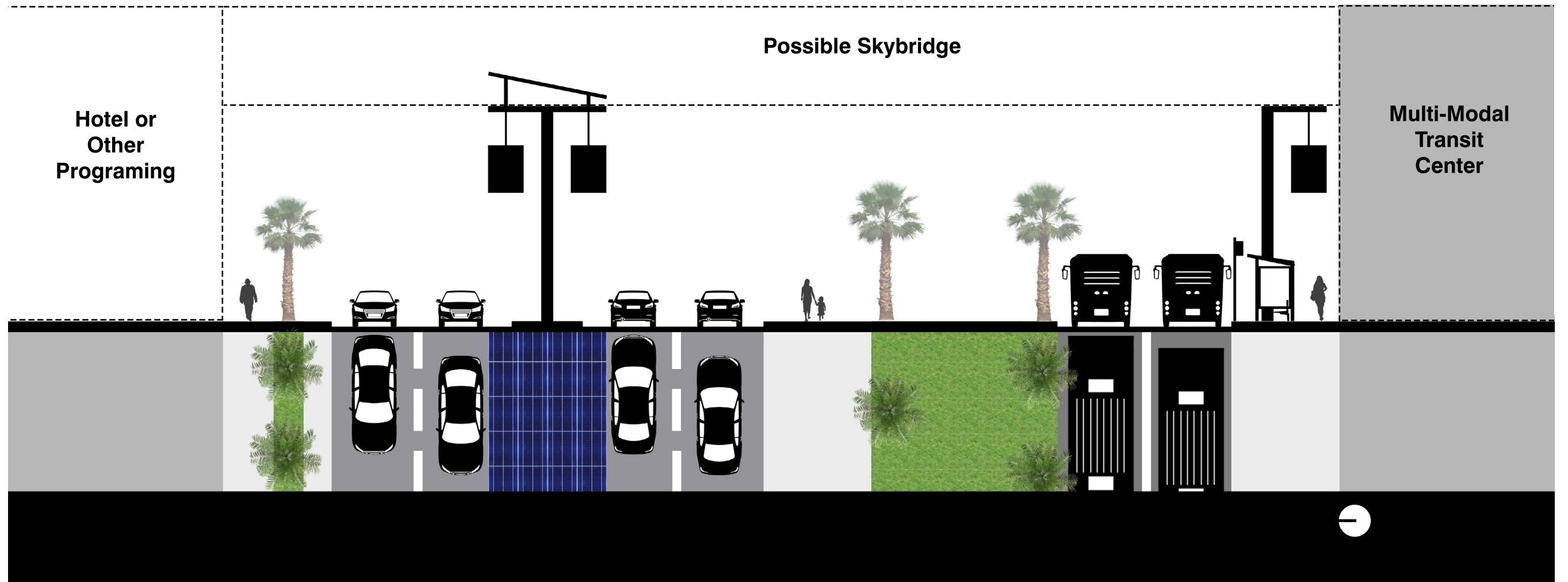



Questions?

